

INSTALLATION&OPERATION INSTRUCTION MANUAL
FOR
CEILING-MOUNTED CASSETTE TYPE

SA-Q04ENG-0

Thank you for choosing our company products!

Air conditioning facilities are valuable products. In order to protect your legitimate rights and interests, please make sure that the installations are done by professional technicians. This manual is a general-purpose version for the conditioning systems manufactured by our CO., the one that you have chosen might be a little different in appearance from the ones described in the manual . But these differences will not have any impacts upon your operation and use of the system.

Please read the manual carefully before you operate the system and check to see if the model is identical to the one you have purchased, keep the manual properly in case you might refer to it in the future.

CONTENTS

PAGE

NOTICES TO USERS	1
PARTS NAME AND FUNCTION	4
INTRODUCTION OF CONTROLLERS	6
INSTALLATION OF THE UNIT	9
TEST OPERATION	17
MAINTENANCE AND UPKEEP	19
TROUBLESHOOTING	22
ELECTRIC WIRING	25

NOTICES TO USERS

1. 1 Safety Notices

" Important Safety Information " affords very important points about how to operate the unit safely. To prevent injury to the user or other people and property damage, the following instructions must be followed. Incorrect operation due to ignoring of instructions may cause harm or damage.

The safety precautions listed here are divided into two categories. In either case, important safety information is listed which must be read carefully.



WARNING

Failure to observe a warning may result in serious injury, grave accidents even death.



CAUTION

Failure to observe a caution may lead to injury or damage to the equipment.

Please read the mark of the unit carefully .If you detect any abnormality, such as abnormal noise, smell, fog, temperature rise, creepage, fire and so on; Please turn off the power supply immediately and call your dealer or local service center for instructions. Do not repair the unit by yourself. If necessary, call the local fire department or Emergency department for help.



WARNING

1. Never install the unit by yourself and call the professionals from distributor or maintenance center for installation, or it may lead to accidents and affect the performance of usage .
2. Never dismantle the units without the guidance of the professionals, or it may cause danger .
3. Do not place insecticides or paints and other flammable sprays near the unit or spray them directly at the unit. It might cause fire hazards.
4. Do not install the main power supply switch at the places where the children might touch it to avoid of accidents .
5. Do not spray water or other liquid to the air conditioner, or else it may cause electric shock.
6. Do not touch the unit with wet hands, otherwise it might cause electric shocks .
7. Disconnect the power during lighting storm day, otherwise it might cause

Lightning shocks or damage the unit .

8. If the unit will be idle for a long time, disconnect the power to avoid of accidents .
9. The unit shall be equipped with special power supply switch and power line to avoid of sharing the same power line with other devices. Besides, it adopts the stated- cross-section wire to supply the power, matching with the corresponding breaker(with creepage protect function) .
10. The unit is connected with the stated-cross-section earth wire, which is grounded safely and is not allowed to be connected with the gas pipe, water pipe, lightning conductor or the telephone earth wire in order to avoid of electric shocks.
11. Never stop the operation of the unit by pulling out the power supply line in order to avoid of electric shocks or fire hazards .



CAUTION

1. Do not put your hands or sticks into the air vents . As the fan running with high speed will hurt you.
2. Keep the electric control system from damp to avoid of circuit-short or damage of unit .
3. After cleaning the filter screen, install the air filter screen quickly .It is not allowed to operate the unit without the air filter screen which may get the poor performances.
4. When there are old men, children and patient in the room, please adjust the room temperature properly.
5. If the unit is interrupted by the lightning or other electromagnetic radiation, cut off the power, restart the unit after eliminating that factors.
6. Do not clog the air inlet and outlet of the unit.
7. Never use the fuse with incorrect capacity or iron or copper wires for fuse .
8. Keep the unit off the places where might happen fire hazards .Pull out the power plug immediately and put down the fire with fire extinguisher result from circuit-short.
9. Cut off the power supply before servicing.
10. Do not touch the pipe on the exhaust side, because the temperature may be above than 100℃, so it may result in scald.
11. Do not touch the fin and sharp edge which will hurt you.
12. Do not move the unit randomly without professional guidance, otherwise it may cause the damage of the unit .

13. Do not touch the rotary air vents with your hands or other objects to avoid of accidents or damage.
14. It is forbidden placing goods above the machine set, so as not to result in the danger of the fall off when they are running.

1. 2 Use notices

1. The unit must be installed in outdoor field where there is sunlitproof and rainproof establishments , or else our company is not responsible for the problems caused because of wrong installation.
2. All the operation parameters of the unit set , the set values of the protective device have been set before the delivery , the consumers are not allowed to change the set values at random , and also are not allowed to make the line of the protective devices of the machine set , short-circuit or the unit may be damaged as result of improper protection.
3. When the unit is running, the unprofessional personnel do not touch any electrical element and buttons, or it will result in serious accident.
4. If the unit goes wrong , don't repair it by yourself , please consult the service center of the company (the consultation telephone number can refer to the back over). If the machine set is repaired by unprofessional personnel , it may result in the machine breakdown or the casualty of personnel.
5. During cleaning the unit, never clean the operational panel with benzene, diluent agent , or chemical cloth and so on , or it will result into fade or the fault function of the buttons ; It is not allowed to directly sprinkle the unit with water or cleaning agent, when it is necessary, please clean them with a cloth that is stained with water or neutral cleaning agent.
6. In order to prolong the service time of the air- condition, please do not start the compressor frequently. (It should not be more than five times in an hour).
7. The refrigerant used in the machine set is noncombustible and innocuous , as for the specific gravity of which is greater than air , so when it leaks, it will diffuse on the ground. As a consequence, if the unit is installed in a room, it must make sure that the ventilation condition is good , or it way result in serious asphyxia when the refrigerant leaks.
8. If the refrigerant leaks, stop the unit as soon as possible, and get in touch with the maintenance and repairmen in time, the flame on the field is forbidden, because if the refrigerant contacts with the flame, it will decompose into harmful gas
9. Please service the machine set termly according to the requirements of the specification , in order to make sure that the operation condition of the machine set is good.

PARTS NAME AND FUNCTION

■ Indoor unit

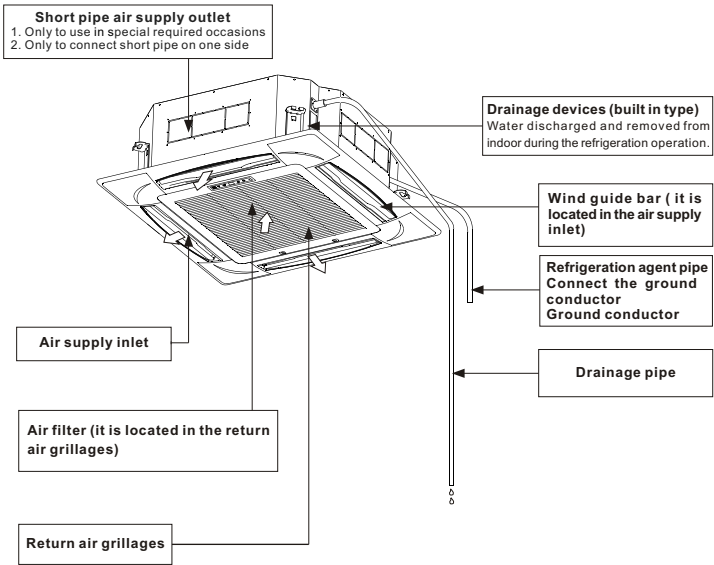

■ Outdoor unit (A. Air outlet B. Air inlet)

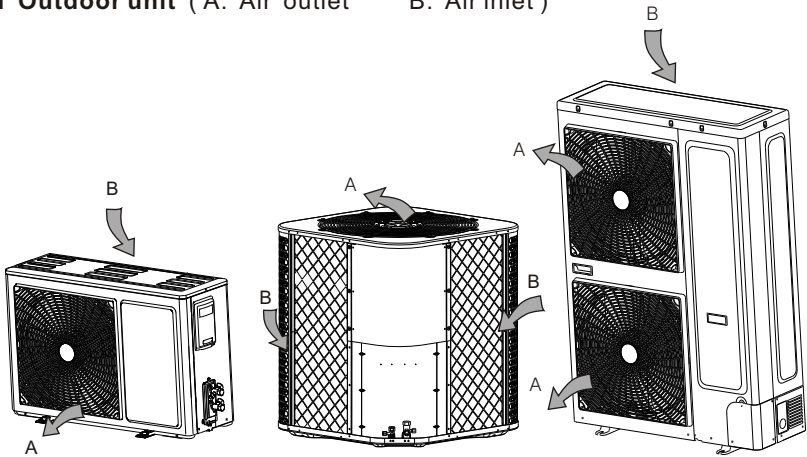

NOTE: The drawings above only can be taken as illumination.

■ The indicator light board of the indoor unit

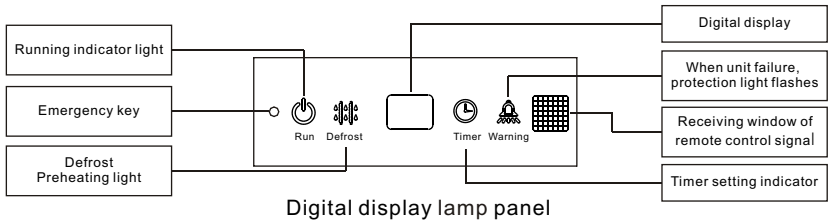
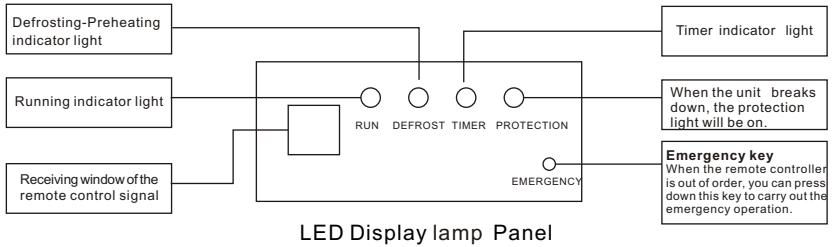

CAUTION

When equipped with Digital display lamp panel, please toggle the fourth point of dialing switches SW1 to DP in the electronic controller of indoor unit, as shown in the right figure:



INTRODUCTION OF CONTROLLERS

2.1 Instruction for Remote controller

The model of the following remote controller is Lingtong common remote controller.

TURBO key, LAMP key, AIR FLOW key and CLEAN key is applicable for special latest developed new models instead of normal ones.

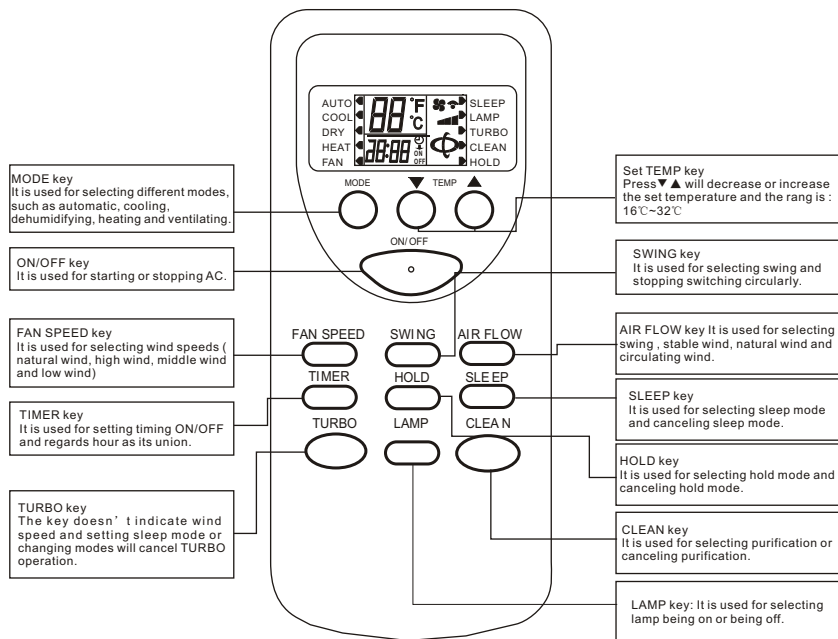

2.2 Introduction of Functional Key

- **ON/OFF key:** Press the key and the remote control will switch circularly in the order : ON→OFF→ON.

When it is powered on at first from off state to on state, the default setting of work condition is (The set temperature is 25°C and the mode , wind speed, swing and air drow are all automatic and there is no LAMP, no TURBO, no CLEAN, no SLEEP, no TIMER and no HOLD function). When it is not powered on firstly from OFF state, the work condition is as the same as the state before stopping. It will cancel LAMP, CLEAN, SLEEP, TURBO and TIME mode.

- **MODE key:** Press the key to switch modes in the order :
AUTO→COOL→DRY→HEAT→FAN→AUTO
- **▼ key:** In DRY mode or AUTO mode, pressing ▼ key cannot change the temperature. In other mode, press the key once and the temperature will decrease 1°C in the order : 32°C→31°C→...→17°C→16°C .
- **▲ key:** In DRY mode and AUTO mode, pressing ▲ key cannot change the temperature. In other mode, press the key once and the temperature will increase 1°C in the order: 16°C→17°C→...→31°C→32°C .

- **FAN SPEED key:** The default wind speed is in the automatic wind mode when starting firstly. The remote control won't react by pressing the key because the wind speed can't be adjusted and in low speed in dehumidifying mode. In other mode, press the key to switch modes in the order : automatic wind→ high speed →middle speed→ low speed →automatic wind.
- **SWING key :** In dehumidifying mode, the swing mode is in the stable wind mode without change. In other mode, press the key to switch modes in the order: swing →stable wind→natural wind →swing.
- **AIR FLOW key :** The default air flow is in the swing mode when starting firstly and press the key to switch modes in the order: SWING →STOP →SWING.
- **TIMER key :** The default mode is in no timing state, press the key to set timing time . The switch order is: 1H→2H→...→24H→cancel→1H... . Press the key to set timing starting in the OFF state and set timing stopping in the ON state. After setting timing function, the time keeps decreasing per hour until the time decreasing to the timing on or timing off and the timing display will be cancelled at the same time . Pressing MODE key can't cancel timing in timing mode which will set out timing time by pressing other key.
- **HOLD key:** The default state is in no HOLD key state, press the key to select modes in order: HOLD key →cancel HOLD key→ HOLD key ; In HOLD key mode, all keys except HOLD key of the remote control can't work .
(**NOTE:** In HOLD key mode, the remote and operation panel of the unit both will be locked automatically by pressing the key and press the key again , they will be unlocked. As for the split unit , it only hold the control other than EMERGENCY key and the panel will make a reaction.)
- **SLEEP key :** Press the key to switch modes in the order: SLEEP→ cancel SLEEP→ SLEEP. The sleeping function won't be cancelled for changing modes. Press the key to set sleep mode and the wind speed will automatically be switched to low speed and it can adjust the wind speed by pressing the FAN SPEED key (except dehumidifying mode).
- **TURBO key:** The default state for the control is no turbo and the key don't work in the AUTOMATIC mode, DRY mode and FAN mode (It will not display any contents and not send out any codes). The control, however, will switch between on and off by pressing the key in other mode. The wind speed isn't indicated in turbo mode and it will be cancelled for changing modes and setting sleep mode.
- **LAMP key :** The default state is in no LAMP key state, press the key to select modes in order : LAMP key →cancel LAMP key→ LAMP key; In LAMP key mode, pressing MODE key can't cancel the show of LAMP key.
- **CLEAN key :** The default state is in no purification state, press the key to select modes in order : CLEAN →cancel CLEAN→ CLEAN; In CLEAN mode, pressing CLEAN key can't cancel CLEAN function. Press the key when the remote control is closed, the control will switch modes in the order : CLEAN →cancel CLEAN→ CLEAN; When you stop the unit and turn on the purification switch, except the wind, the stable swing and air door swing speed aren't adjusted.

2. 3 Notices for operating the remote control

- ① Don't place the control near high heat source such as Electric blanket, warm furnace and so on.
- ② Don't expose the control in sun.
- ③ Take care for it and prevent it from damage for falling down.
- ④ Don't place any rolling obstacle between the signal acceptor of AC and the control, otherwise it may affect sending or incepting signals.
- ⑤ Don't spray water or other liquid on the control.
- ⑥ Don't place any clog on the control.

NOTE: When the remote control is out of work, please replace the battery and operated it once ; If the failure hasn't be cancelled, please take urgent operation methods to restart the AC.

2. 4 Replace batteries of the remote control

If the following condition appears, which mean that the batteries have been used up, please take out of the old batteries and change for new ones.

- ① After sending the signal, the air conditioner can not send receiving sound.
- ② The display screen is not clear

The operating steps are as follows:

- Remove the back cover, take out of the old batteries.
- Replace batteries, please notice the poles “+” and “-” on the batteries.
- Close the back cover and set the current time.
- Make sure whether it indicates a.m. 0:00 or not.

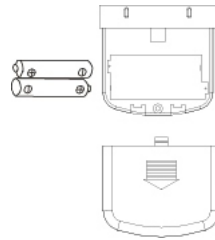

Pay attention to poles of “+” and “-”



NOTE

- 1. New and old batteries can not be used together.
- 2. If the remote controller will not be idle for long time, please take out of the batteries.
- 3. The service life of the dry batteries, accorded with the requirements of the standard of JIS or IEC, is 6 to 12 months under common condition ; Overrunning the service time or using dry batteries, which are not accorded with the above mentioned specifications, the liquid seeping phenomenon may be occur on the battery and the remote control won't work.
- 4. There is “Advised Service Time” marked on the battery, the practical service time may be shorter than the advised one.

INSTALLATION OF THE UNIT

4. 1 Install Indoor unit

4. 1. 1 Installation place

When the temperature of the ceiling inside is higher than 30°C, and RH is higher than 80%, More than 10mm heat insulation materials, such as fiber glass cotton or froth polyethylene should be slicked on the casing of the unit. (if the thickness of the heat insulation materials is more than 10mm, the extra part should be folded up and placed in the opening of the ceiling).

- The indoor unit can be installed on the ceiling with the height of 2.5~2.5mm.
- When installing the indoor unit, the lifting screw rod will be used and make sure installation foundation is firm enough to support the unit, otherwise, please take some measurings to reinforce it prior to installation. The hole pitch has been marked on in the installation paper matrix, please refer to those specification and find out the places where the reinforcing measures should be taken.
- Make sure there is no obstacles in the place where is 1meter away from the air outlet.

Installation space

unit: mm

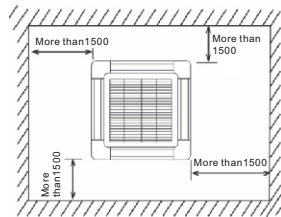
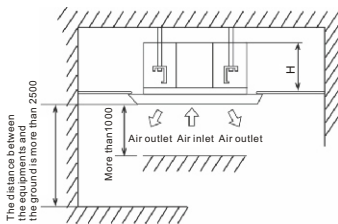

Installation dimension

unit: mm

Model (kBtu/h)	Dimensions(H)
For 18, 24 series	230
For 36, 48, 60 series	285

4. 1. 2 Installation procedures for indoor units

- The position relationship between the opening in the ceiling, the unit and the lifting screw

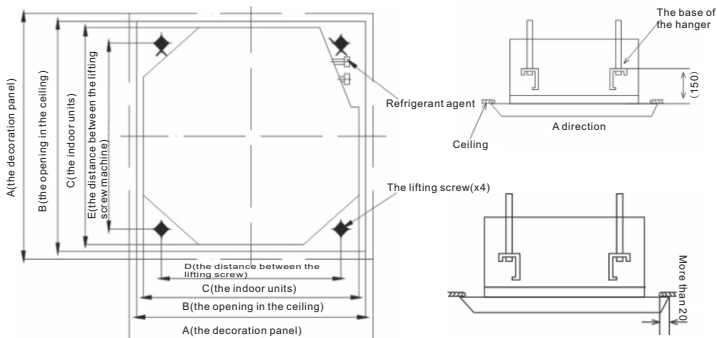

unit: mm

Model (kBtu/h)	Dimensions(H)				
	A	B	C	D	E
For 18, 24, 36, 48, 60 series	950	890*	840	680	780

NOTE:

- ① The dimensions of the opening of the ceiling marked by the star symbol can surpass 910mm, but the overlap sections of the ceiling and the decoration panel should be more than 20 mm.
- ② As for existing ceiling, a proper opening for installation should be dig
 - a. On the installation paper-matrix, you can get the detailed information about the dimensions of the opening of the ceiling.
 - b. Before installation, please finish the installation of all ducts (refrigerant duct, drainage duct)and the connection of the all power lines(the power lines of the outdoor unit), once the installation has finished, the ducts and the power lines can be connected with the indoor units immediately.
 - c. The opening in the ceiling can reinforce the ceiling and prevent the ceiling from vibrating.

■ The installation of the lifting screw(using the W3/8 M10 bolt)

- ① In order to support the unit, the ground anchor bolts are needed for existing ceiling and as for new built house and ceiling, however, buried anchor bolts or other parts (supplied in the field site) .
- ② And then adjust the distance between anchor bolts and the ceiling.

4. 1. 3 Installation for indoor units

unit: mm

■ When there is no installation position in the ceiling board

- ① Attach the base of the hanger on the lifting screw, the nuts and washers are used in two ends of hanger base to firmly fix the base. Besides, the washer positioning board is used to prevent the washer from falling off.
- ② As for the dimensions of the opening of the ceiling, please refer to the installation paper-matrix or consult the constructor or the carpenter.

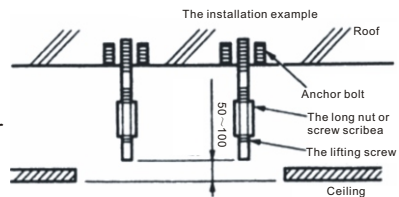

NOTE: all the parts above mentioned will be supplied at the installation site

The installation paper-matrix is fixed on the unit with three screws and on the paper-matrix, the central position of the opening in the ceiling has been marked out . The corner of the water drainage groove at the water outlet of the duct is also fixed by screws.

- ③ Adjust the unit to the correct installation position.
- ④ Check whether the unit is in the horizontal level.

Because the indoor unit has inside water drainage switch and float switch. Check the four corners of the units separately to make sure that the four corners are in the horizontal level by using the level gauge or the polythene duct filled with water (if the unit inclines to the reverse direction to the flow of condensation water, it may lead to the float switch out of work and result in water dropping).

- ⑤ Remove the washer positioning board and fasten the nut .
- ⑥ Remove the installation paper-matrix.

■ When there is installation position in the ceiling board

- ① Temporary installation of the indoor unit

Attach the base of the hanger on the lifting screw, the nuts and washers are used in two ends of hanger base to firmly fix the base. Besides, the washer positioning board is used to prevent the washer from falling off.

- ② Adjust the position and the height of the unit
- ③ Carry on the operation procedure of ④ and ⑤ steps above ;

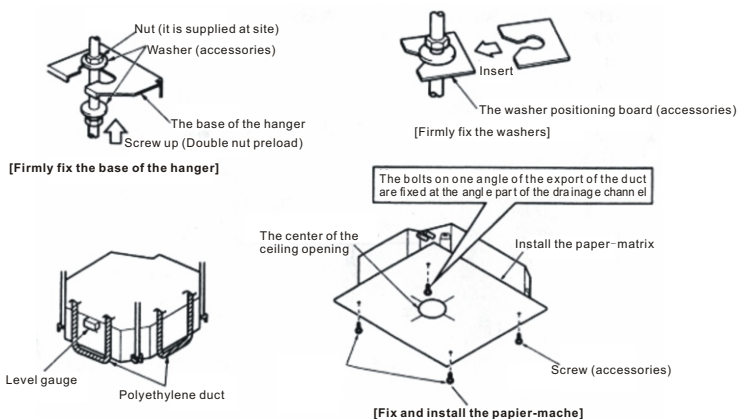

4. 1. 4 Install the panel



CAUTION

- Never keep the panel facing the ground nor again the wall or on protuberant objects.
- Never crash or strike the swing plate in case of breakdown.

■ Take down the return air grill from decoration p

- ① Press the button of the return air grill, and then lift one end of the button (Refer to the left figure)

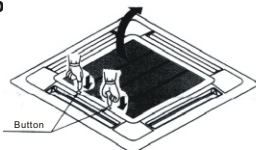

- ② Draw the grill up to an angle of about 45° , and remove it (Refer to the right figure)

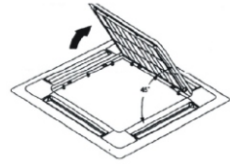

■ **Remove the seal cover at the four corners**

(Draw the seal cover out , Refer to the right figure)

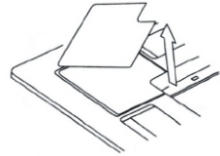

■ **Install the panel**

- ① Align the swing motor on the panel to the tubing joints of the body properly.
(Refer to the following figure)
- ② Hang the draw hooks opposite to swing motor of the decoration panel on the hooks of the indoor unit. (Refer to the following figure)
- ③⑥ Then hang the other two panel hooks onto corresponding hangers of the body.
(Refer to the following figure)
- ④ Screw the four hexagonal screws under the draw hook into approximately 5mm.
(the panel will raise along with it)
- ⑤ Screw up the screws so that the thickness of the air-proof materials between the panel and the indoor unit reduces to 5 ~ 8mm.

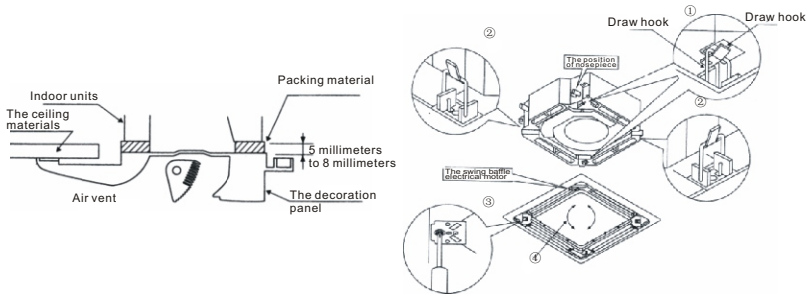

CAUTION

Do not coil the wiring of the swing motor into the seal sponge.

If the screwing is too loose, it will cause following faults. Therefore, screw up the screw again to the stated requirement.

After finishing twisting the screw, if there is still slit between the ceiling and the decoration panel, please readjust the height of indoor unit.

When indoor unit is located in the horizontal position but the drain water can not be drained out, please adjust the height of the indoor unit through the angle hole on the decoration panel.

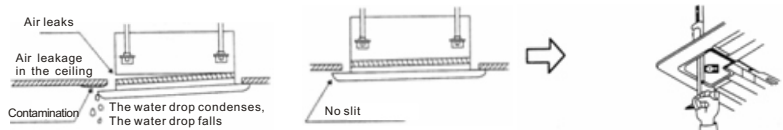

■ Lifting height of the indoor unit

Please adjust the lifting height of the indoor unit as the right figure:

① If there is slit between indoor unit and panel, it will be harmful as the following:

- a. Condensation will be generated outside (ceiling inside) and inside the product because of the air in the ceiling or the gas leakage from the ceiling.
- b. The horizontal leaf blade will condensate, the water will splash and condensation will be generated in the machine because of air current blowing out disorderly.

② The circuitry of the decoration panel (please see the right figure)

- a. The connector of the wire of the swing electrical motor should be properly attached (located on decoration panel)
- b. If unconnected, then the swing plate will not act
- c. Insure that the wire of the swing electrical motor is not trapped between indoor unit and the decoration panel.

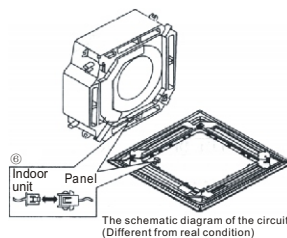
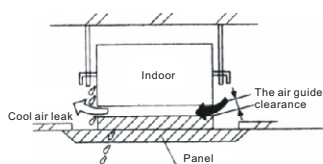
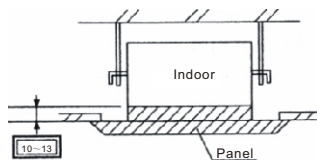

4. 1. 5 Install return air grill and close cover

■ Install the return air grill

Following the opposite installing steps with "4. 1. 4 Install the panel" to carry on the installment. Rotating the return air grill, it may be installed in 4 directions. If needing to adjust the installment direction of the return air grill, or users put forward new requirement, installment direction can be changed.



CAUTION

Do not coil the wiring of the swing motor into the return air grill when installing.

- Fix the close cover on the panel (refer to the following figure)

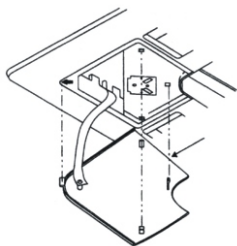

Insert the four pins on the close cover into the corresponding hole on the decoration panel before installation.

- Put the return air grill on the panel and then connect the swing motor on panel and lead connectors of control box to the corresponding joints of the main body;
- Install return air grill according to the opposite steps for removing the grill.
- Reinstall the installation cover plate
- Fix the rope of the installation cover plate with screws on the bolts of the installation cover plate (please refer to the lower right figure)
- Push gently the installation cover plate into the panel.

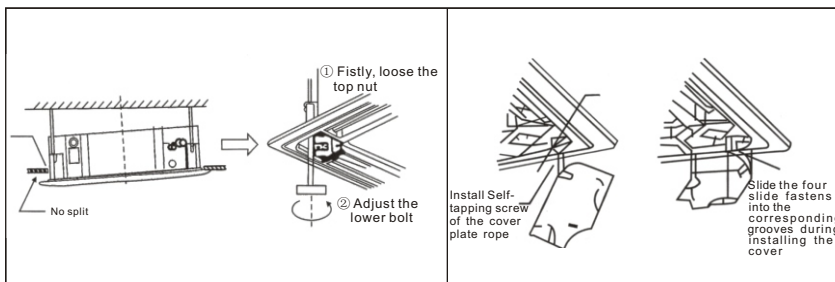

4. 2 Install Outdoor unit

4. 2. 1 Installation precaution

- It is advisable to transfer the parts of the unit with complete packing to the installation field site.
- Pay attention to the lifting of the unit, for its center of gravity not at the central position.
- Keep the outdoor unit not incline too much, the angle not more than 45° during transportation(it is not allowed to store the unit in level in the storehouse)

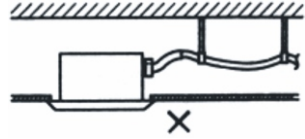
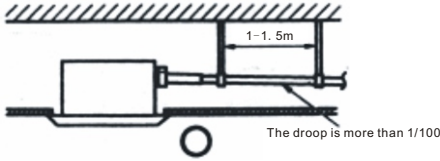

■ Use Drain hose ① and Clip ② (Attachment).

Insert the drain hose into the drain faucet to the white adhesive tape and then screw down the clip so that the distance between the bolt head and hose is less than 4 mm.

■ In case of water leakage for dewing, please take some heat-insulated measures for the indoor drain hose and the drain faucet.

- Drain pipe in the room;

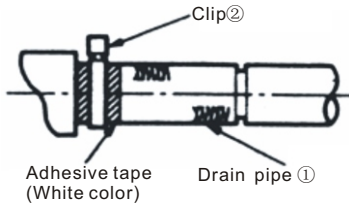

- Drain faucet

Carry on heat insulation operation for the clip and drain pipe with Large-size sealing gasket ⑩

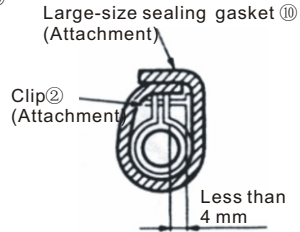

■ Notes of the drain lifting duct

1. The installation height of the drain lifting duct is less than 550mm;
2. Keep the lifting duct with the unit in vertical and the distance less than 300 mm.

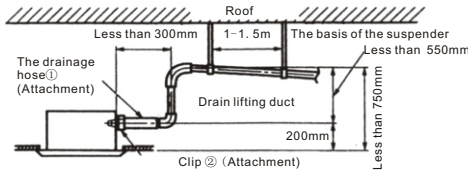

CAUTION

- In case of water leakage, please don't drag the drain pipe violently;
- Please install the drainpipes according to the following steps if several drain pipes are converged in one drain pipe.



- **Step one** Choose the proper join drain pipe according to the running capacity of the unit.
- **Step two** After the installation of the drain duct, inject 2000ml water into the air vent or the service port, and then check whether the drainage is free ;
- **Step three** After the installation of the circuit , check the drainage condition during cooling operation, as for the details, please refer to "TEST OPERATION".

Water injection sketch figure

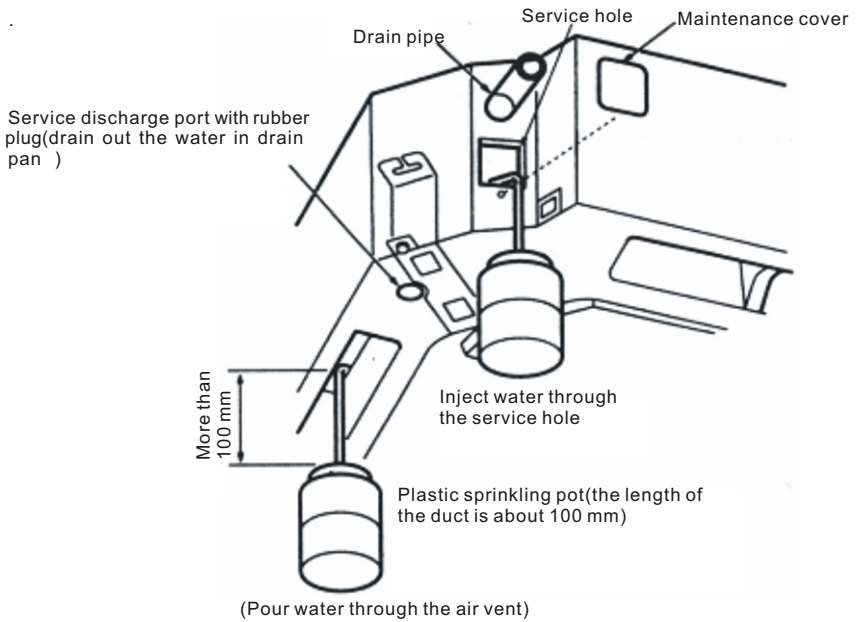

TEST OPERATION

5. 1 Please confirm the following points before the test operation:

- The indoor unit and outdoor unit are installed properly.
- Tubing and wiring are correctly completed.
- There is no leakage in refrigerant pipe system .
- The drainage is unimpeded.
- The heating insulation works well.
- The ground wiring is connected correctly.
- The power voltage fits the rated voltage of the air conditioner.
- There is no obstacle at the outlet and inlet of the outdoor and indoor units.
- The gas-side and liquid-side stop valves are both opened.
- The air conditioner is pre-heated by turning on the power.



CAUTION

The compressor can not run unless the power wires are connected well.

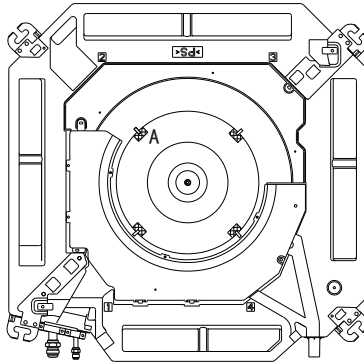

CAUTION

Be sure to remove the four wind wheel absorber blocks (A) and the fixing tape before test running!

5. 2 Test operation

- Switch on the main power supply of this unit.
- Press the emergence operation switch(cooling or heating) to start up the air conditioner, and the operation indication light flashes. Check whether the unit is running well and if you want to shut down the air conditioner, just press the emergence switch again.
- Press “ON/ OFF” key on the remote controller, if you can hear “beep ” sound from the indoor unit, it means the remote controller is working and the emergency operation has been relieved , and then you can check whether the unit can run well in each mode by pressing the corresponding keys:
 - Press “MODE” key and choose FAN mode, check whether there is air flow blowing out from the air conditioner.
 - Press “MODE” key and choose COOL mode, check whether the air flow blowing out from the air conditioner is cool.
 - Press “MODE” key and choose HEAT mode, check whether the air flow blowing out from the air conditioner is warm.(This function is not applicable for single-cooling type unit.
 - Press “WIND SPEED” key and choose the high speed mode, check whether there is a strong air flow blowing from the air conditioner.
 - Press the “SWING ” key and observe Whether the air flow louver moves normally.

5. 3 Test drainage device

- After the installation of the unit, you must carry out a test of the drainage equipments
- During test operation, make sure that the water in the equipment is drained freely and no leak at the joint.

After the installation and the commissioning of the unit , the installation personnel should introduce methods of operation and use of the unit and the relevant safety notes according to the operation manual.

MAINTENANCE AND UPKEEP

6. 1 Clean the air filter

If the air filter is blocked, it will reduce the air circulation amount and affect the effect of the cooling air and the warm air ; What' s worse, it will lead to the air conditioner break down. Therefore, please clean the air filter at least once every two weeks during long time usage.

If the unit will is idle for a long time, the air filter should be cleaned before starting the unit.

6. 1. 1 The cleaning procedures of the air filter

- Dismantle the air filter
- Clean the filter with the dust collector or water
- If the filter is cleaned with water, place it in a shady and cool place to dry.



CAUTION

-
- In case of fading or deformation of the filter, never clean it with the hot water of which the temperature is higher than 50°C ;
 - Never dry the strainer by a fire, otherwise, it may catch fire.
-

When you clean or upkeep the unit, firstly , you must turn off the power supply of the unit and pull out the power plug. And the cleaning or maintenance should be operated by professional personnel.

6. 1. 2 The cleaning methods of the indoor unit

- Wipe the outside of the unit with a clean and soft dry cloth
- Use the neutral domestics cleanser agent(such as clean agent) to clean any oil contamination or the fingerprint

6. 2 Dismantle the return air grill and the air filter

■ Open the return air grill: Press the two buttons, and pull them downwards slowly as indicated in the right figure (when closing the return air grill, follow the same operation steps):

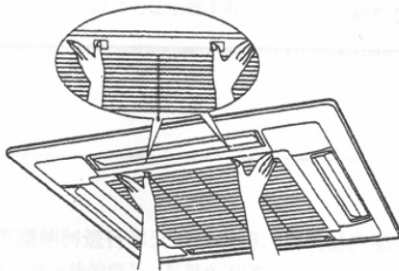

■ Dismantle the air filter net: hold on the draw hook of the air filter and pull it along the lower inclined side to take out the strainer as indicated in the right figure:

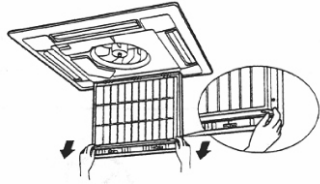

■ Take out the return air grill: Open the return air grill at the angle 45 ° and then lift it up and take it out, just like the right figure.

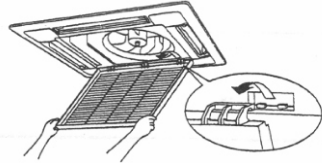

■ Install the air filter and the return air grill after cleaning them according to the opposed operation steps above, as indicated in the right figure.

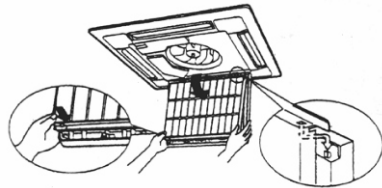

6. 2 Set indoor temperature

In the cooling mode, It is comfortable when the temperature difference varies in 5°C between the indoor temperature and the outdoor temperature varies in 5°C . If the indoor temperature is too low , it will not only do harm to your health but also consume more electric energy: For example, it will reduce 10% energy consuming by increasing 1 °C of setting temperature in cooling mode.

6. 3 Away from the heat source

When the air conditioner is operating in cooling mode , you should close the curtain to ward off the sunlight ; Besides close the windows and doors and don't open the door in too short time if not necessary.

6. 4 Ventilate and exchange air of the room

You will feel more comfortable if you open the windows at a regular interval to let the fresh air into the room.

6. 5 Maintenance after a long stop period

(eg. at the beginning of the season)

- Check whether the installation of the outdoor unit and the connection of the grounding lines and power cables are all in good condition.
- Check and remove everything that might be blocking inlet and outlet vents of indoor units and outdoor units.
- Check whether the air strainer is installed in the right place.

6. 6 Maintenance before a long stop period

(eg. at the end of the season)

- Turn on the air conditioner and let it run in FAN operation for about 3 or 4 hours in order to dry the interior of the units.
- Turn off the air conditioner and cut off its special power supply .
- Clean air filters and casings of indoor units.
- Take out the batteries of the remote controller and put away the remote controller.
- Cover the units with a protective cover to prevent the duct from coming into the unit.

TROUBLESHOOTING

7. 1 Malfunction analysis

When air conditioner goes wrong before you contact the servicing department, please read the following contents, it will help you save much more time and energy.

Problems	Phenomena	Causes	Solution
Air conditioner fails to run	Press "ON/OFF" key on the remote controller, no "beep" sound comes from the indoor unit and the RUN light is off	Power failure	Press "ON/OFF" key after comeback of power
		Power switch is off.	Turn on power supply
		Fuse of power switch may have burned.	Replace the fuse
		The creepage switch is off	Turn on the creepage switch
		The remote controller is working out of the function range	Operate the remote controller in the function range of the remote controller
		Batteries of remote controller exhausted (Information on the screen darken)	Replace them with new batteries
Air conditioner fails to start	Remote controller indicates that the air conditioner is working	Be in 3 minutes protection of compressor.	Wait or call your dealer for service
After starting up, the air conditioner will stop working in a short time		Air inlet or outlet of the indoor or outdoor unit are blocked	Eliminate all dirties and make air smooth.
	The air filter is dirt	Clean the filter	
Air flow is normal but the air blew out is not cool or warm	Remote controller indicates that the air conditioner is working	Temperature is not set correctly, too high in COOL mode or too low in HEAT mode	Set the temperature properly.
		The air filter net has been blocked with dust or dirt	Clean the ail filter net
		Air inlet or outlet of the indoor or outdoor unit are blocked	Eliminate all dirties and make air smooth.
		Doors and windows are open	Close doors and windows

Once the air conditioner break down for power failure , it can start only by pressing "ON/OFF" key on the remote controller even if the power restores.

7.2 Self-fault diagnostic function

Our company will provide convenient service to our customers, and install all kinds of judgment systems, which can display the unnormal function of the unit .

Fault codes table(1)

4LED Faults	Digital display	Failure description
Timer light flashing	E2	Ambient temperature sensor (T1) failure
Running light flashing	E3	Evaporator pipe temperature sensor (T2) failure
Defrost light flashing	E5	Condenser pipe temperature sensor (T3) failure
Warning light flashing	F5	Water fullfilled protection
Running light, defrost light flashing	E1	Indoor unit and wire controller communication failure
Running light, timer light flashing	P6	Indoor unit EEPROM failure
Defrost light, timer light flashing	F0	Indoor fan stall protection
Defrost light, warning light flashing	F2	Outdoor protection
	F7	outdoor unit over-current protection
Timer light, warning light flashing	E0	Indoor unit and outdoor unit communication failure
Running light, defrost light, timer light flashing	F3	High pressure protection
Defrost light , timer light, warning light flashing	F4	Low pressure protection
Running light, timer light, warning light flashing	F8	Outdoor unit exhaust temperature over-high protection
Running light, defrost light, timer light, warning light flashing	F9	Three-phase electricity phase sequence failure
Note: the flashing frequency for all above indication lights is 1HZ.		

Fault codes table(2)

Faults	LED
High or low pressure failure	Green light flashes once every 5s
Temperature sensor T3 failure	Green light flashes 2 times every 5s
Overflow test failure	Green light flashes 3 times every 5s
Phase sequence test failure	Green light flashes 4 times every 5s
Exhaust temperature over-high failure	Green light flashes 5 times every 5s
Exhaust temperature failure	Green light flashes 6 times every 5s

Following cases are not air conditioner troubles

1. Sometimes, air conditioner may give off odours, for the unit can absorb the smell of rooms, furniture, cigarettes, makeup, etc., and then emit it again.
2. A continuous low hissing sound is heard when the system is in operation. This is the sound of refrigerant gas flowing through both indoor and outdoor units.
3. When starting up or stopping the air conditioner, you can hear “cracking” sound from the air conditioner, this sound is produced by the contraction or the expansion of the structural part of the air conditioner, which is caused by temperature change

ELECTRIC WIRING

8. 1 Electric wiring precaution

- Wiring construction must conform to National Wiring Norm;
- The air-conditioner should apply special power supply and set leakage protective switch. The rated operation current of the switch should be no less than 1.5-3 times of the rated operation current of the unit(The actual value of rated current of the unit is list on its nameplate and the one in this manual is just for a reference) ;
- Make sure unit voltage and select proper wires prior to wiring;
- Wiring construction and connections of other individual parts must be conducted by the professional technicians according to the circuit diagram attached on the unit.
- Please pay attention to marks at the terminal in case of wrong connection.
- In case of grave accidents, never mistake the signal terminal of indoor units with the one of outdoor units;
- Please tighten screws to avoid of wires drop according to the wiring diagram.
- Install equipments with the auxiliary electric heater outside the evaporator and keep them 5cm away from the flammable;
- Make sure there is enough space for electric devices installation and the minimum allowable distance between devices;

8. 2 Power wiring diagram

There are many kinds of power wiring diagram for different user powers and models, take double-temperature units for examples:

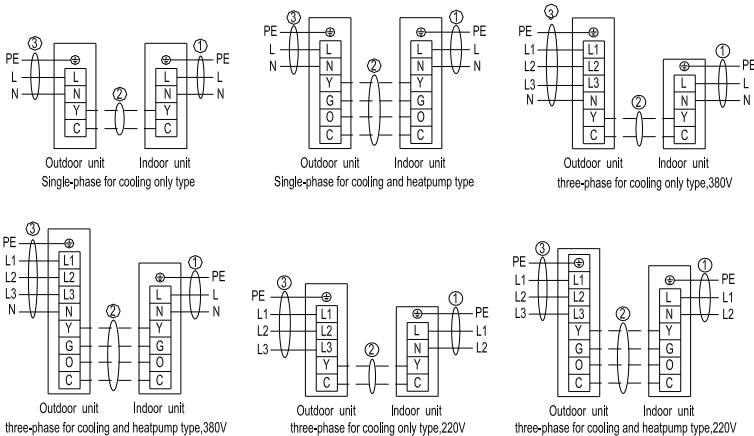

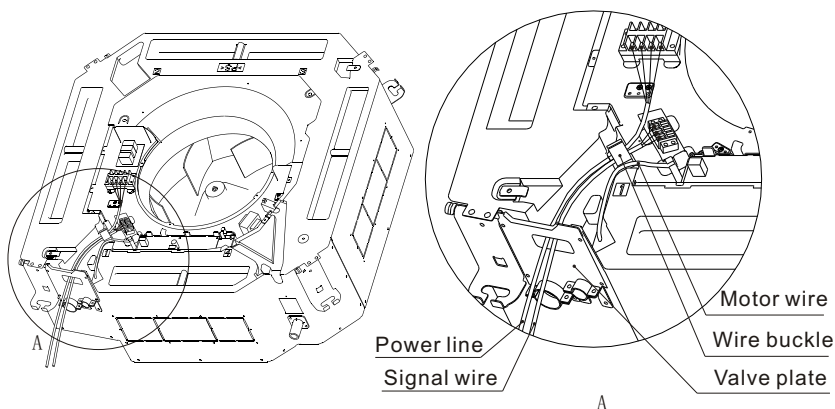

Note: The arrangement diagram is only for signal wire and power line. For wiring, please refer to power wiring diagram.

8. 3 Cables wiring construction of indoor units

- Take down the cover of indoor electric control box;
- Connect power cables and signal wires to the corresponding terminals according to Power Wiring Diagram above;
- Open the cord cleat and then fix power cables and signal wires on the board of the cord cleat;
- Fix on the electric control box

8. 4 Power Wires Spec. Table

Items Model (kBtu/h)	Outdoor power wires	Indoor power wires	Signal cables	Power supply types
24series(single-phase)	3 x 2.5mm ²	3 x 1.0mm ²	≥0.75mm ²	Outdoor and indoor units supply separately
36 series (single-phase)	3 x 4.0mm ²	3 x 1.0mm ²		
48/60 series (single-phase)	3 x 6.0mm ²	3 x 1.0mm ²		
48/60 series (three-phase/380V)	5 x 2.5mm ²	3 x 1.0mm ²		
48/60 series (three-phase/220V)	4 x 4mm ²	3 x 1.0mm ²		

